

PARTS CATALOGUE

Cal. H461A

H461A (2j)

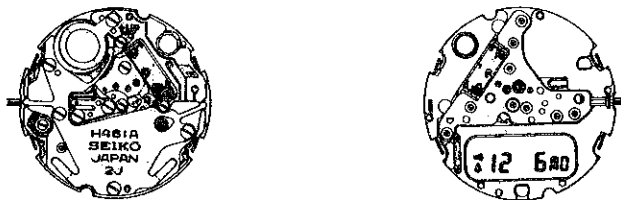

HATTORI SEIKO CO., LTD.

SEIKO

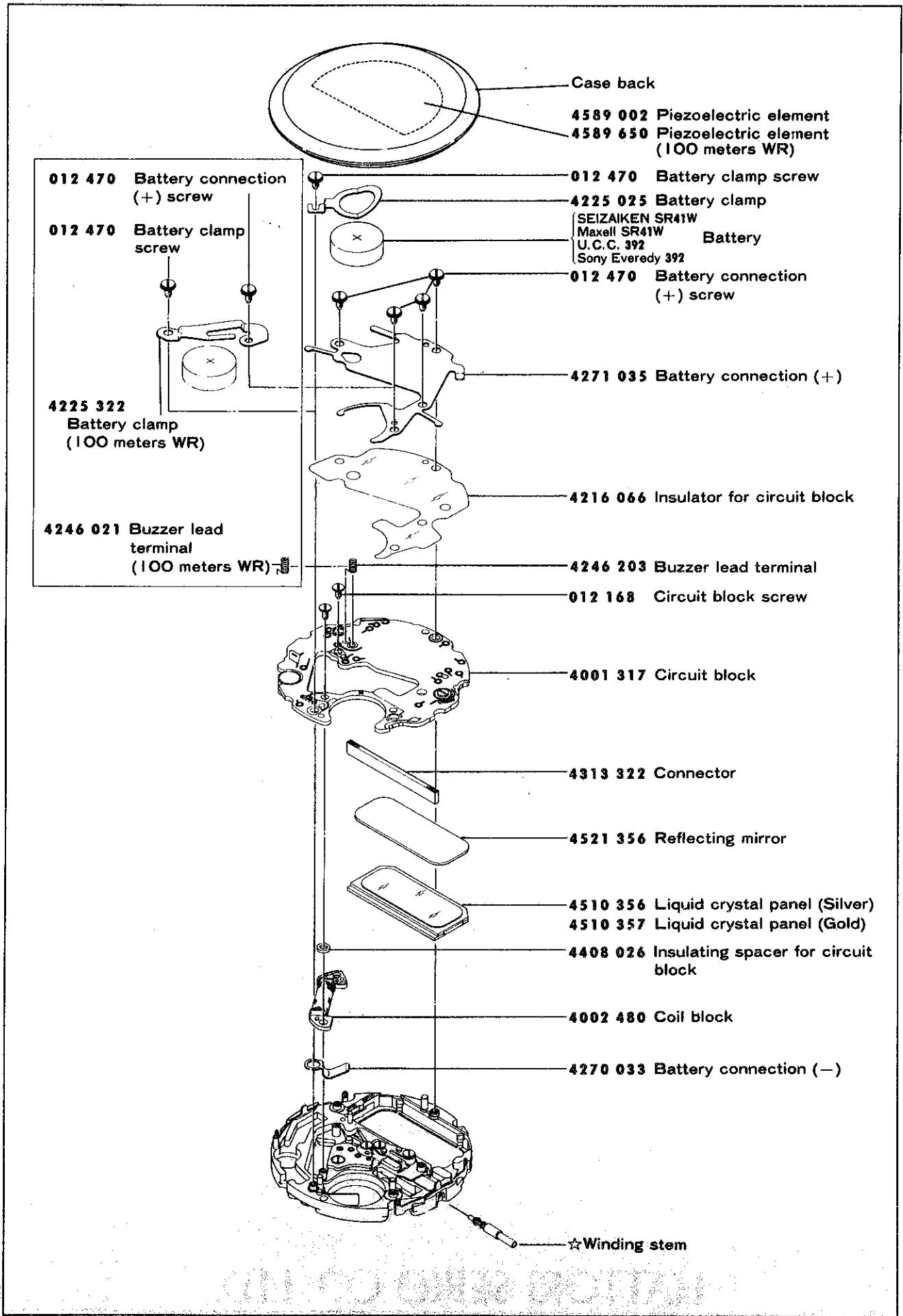

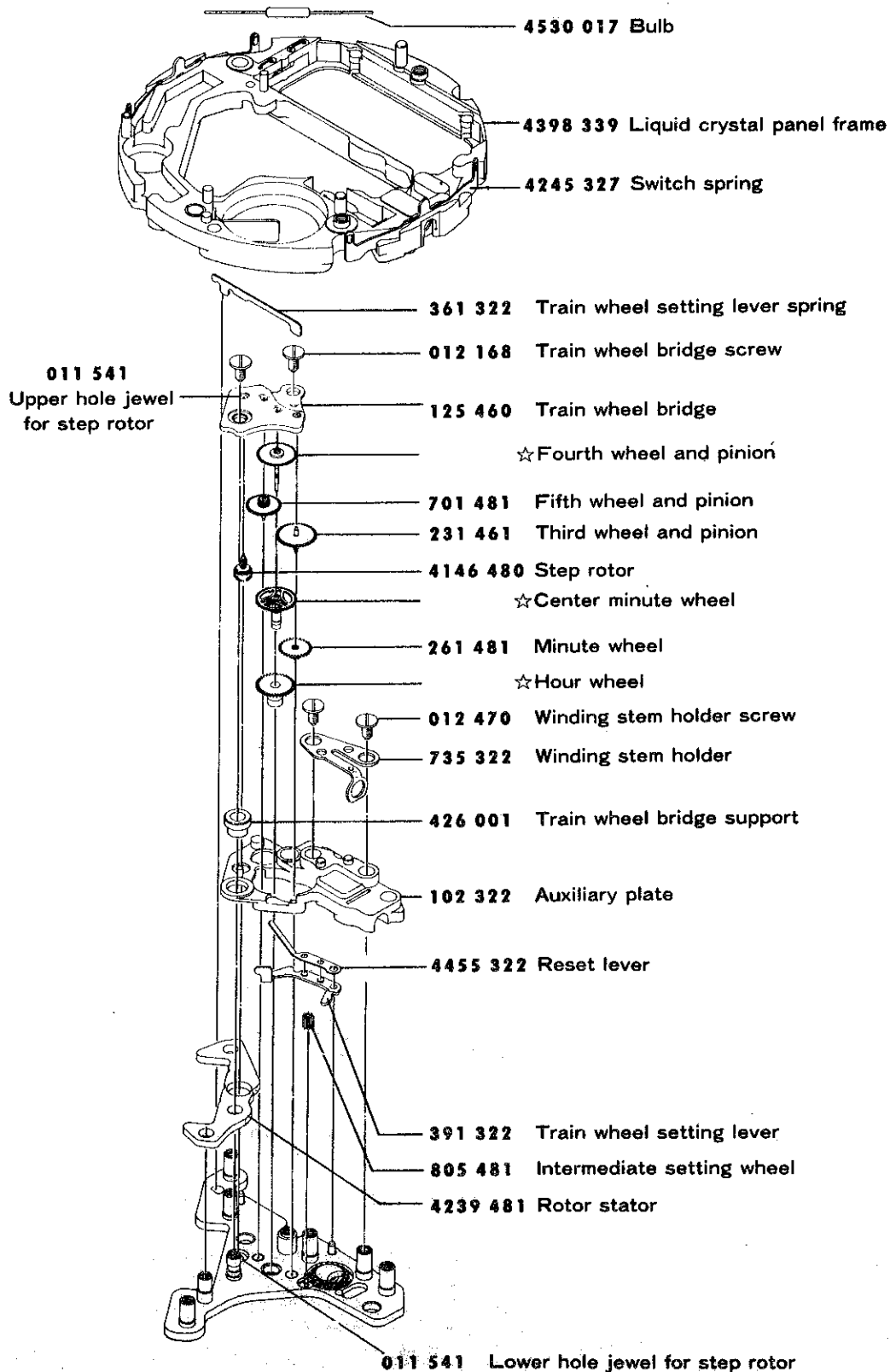



Remarks :



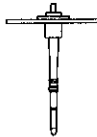
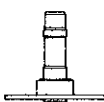

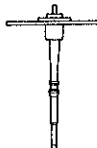
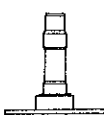
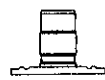



Fourth wheel & pinion, Center minute wheel, Hour wheel

There are two different types as specified below.

Type	Fourth wheel & pinion	Center minute wheel	Hour wheel
a.	 ☆241 481	 ☆270 481	 ☆271 064
b.	 ☆241 482	 ☆270 482	 ☆271 082

Winding stem

☆354 323 } If the combination of the winding stem and case is unknown, check the case number
 ☆354 324 }and refer to "SEIKO Quartz Casing Parts Catalogue" to choose a
 ☆354 325 } corresponding winding stem.

 012 168	Circuit block screw Train wheel bridge screw	 017 286	Tube for battery connection (+) screw (B)
 012 470	Battery clamp screw Battery connection (+) screw Winding stem holder screw	 017 298	Tube for train wheel bridge (A)
		 017 653	Tube for circuit block screw (A)
		 017 654	Tube for circuit block screw (B)
		 017 655	Tube for train wheel bridge (B)
		 017 656	Tube for battery clamp screw Tube for winding stem holder screw Tube for battery connection (+) screw (A)

TECHNICAL GUIDE

SEIKO

QUARTZ

CAL. H461A

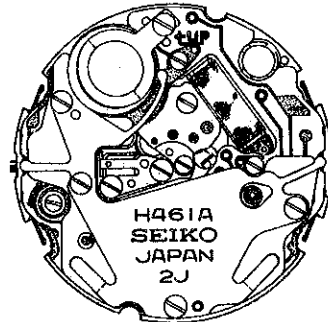
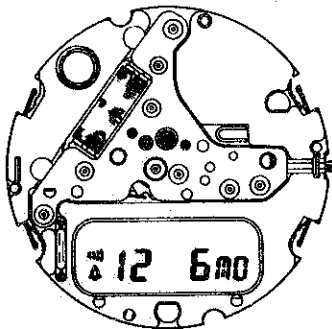

I. SPECIFICATIONS

Item		Cal. No.	H461A
		Analogue section	Digital section
Display medium		3 hands	Nematic Liquid Crystal, FEM (Field Effect Mode)
Driving system		Step motor	Multiplex
Display system			<ul style="list-style-type: none"> • Time (12- or 24-hour indication) • Calendar • Alarm (Rings for 20 seconds) • Stopwatch (60 minutes)
Additional mechanism		<ul style="list-style-type: none"> • Electronic circuit reset switch • Train wheel setting device 	<ul style="list-style-type: none"> • Alarm test system • Hourly time signal • All segments light-up system • Illuminating light
Loss/gain		Monthly rate at normal temperature range: less than 15 seconds	
Movement size	Casing diameter	φ28.0 mm	
	Height	3.4 mm (4.0 mm including battery)	
Regulation system		Trimmer condenser	
Measuring gate by quartz tester		Any gate can be used.	
Battery		Battery life is approximately 2 years for SEIKO (SEIZAIKEN) SR41W, SONY EVEREADY 392, and U.C.C. 392. Battery life is approximately 1.5 years for Maxell SR41W. Voltage: 1.55V	
Jewels		2 jewels	

II. STRUCTURE OF THE CIRCUIT BLOCK

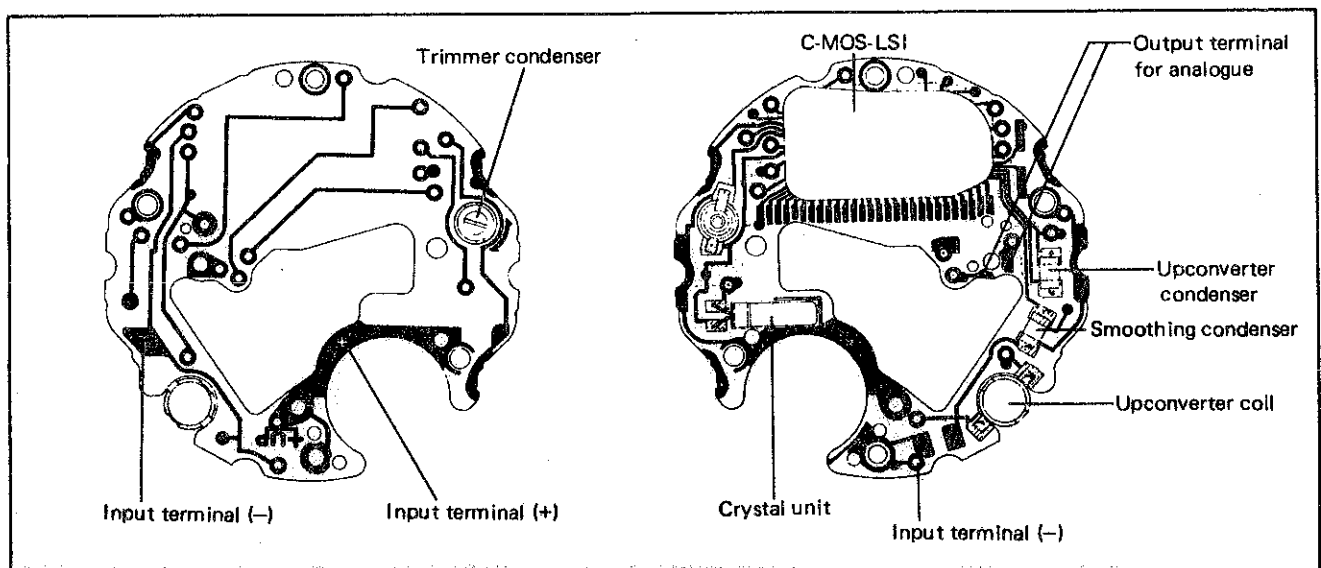

III. DISASSEMBLING, REASSEMBLING, AND LUBRICATING

List of the screws used

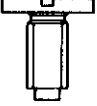
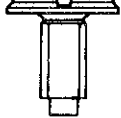
Shape	Part No.	Name	Shape	Part No.	Name
	012 168	Train wheel bridge screw (2 pcs.)		012 470	Battery clamp screw
		Circuit block screw (2 pcs.)			
					Battery connection (+) screw (4 pcs.)

Disassembling procedures Figs. : ① → ③⑧

Reassembling procedures Figs. : ③⑧ → ①

Lubricating:

Types of oil

 Moebius A

 SEIKO Watch Oil S-6

Oil quantity

 Normal

1. Second hand ~ Dial

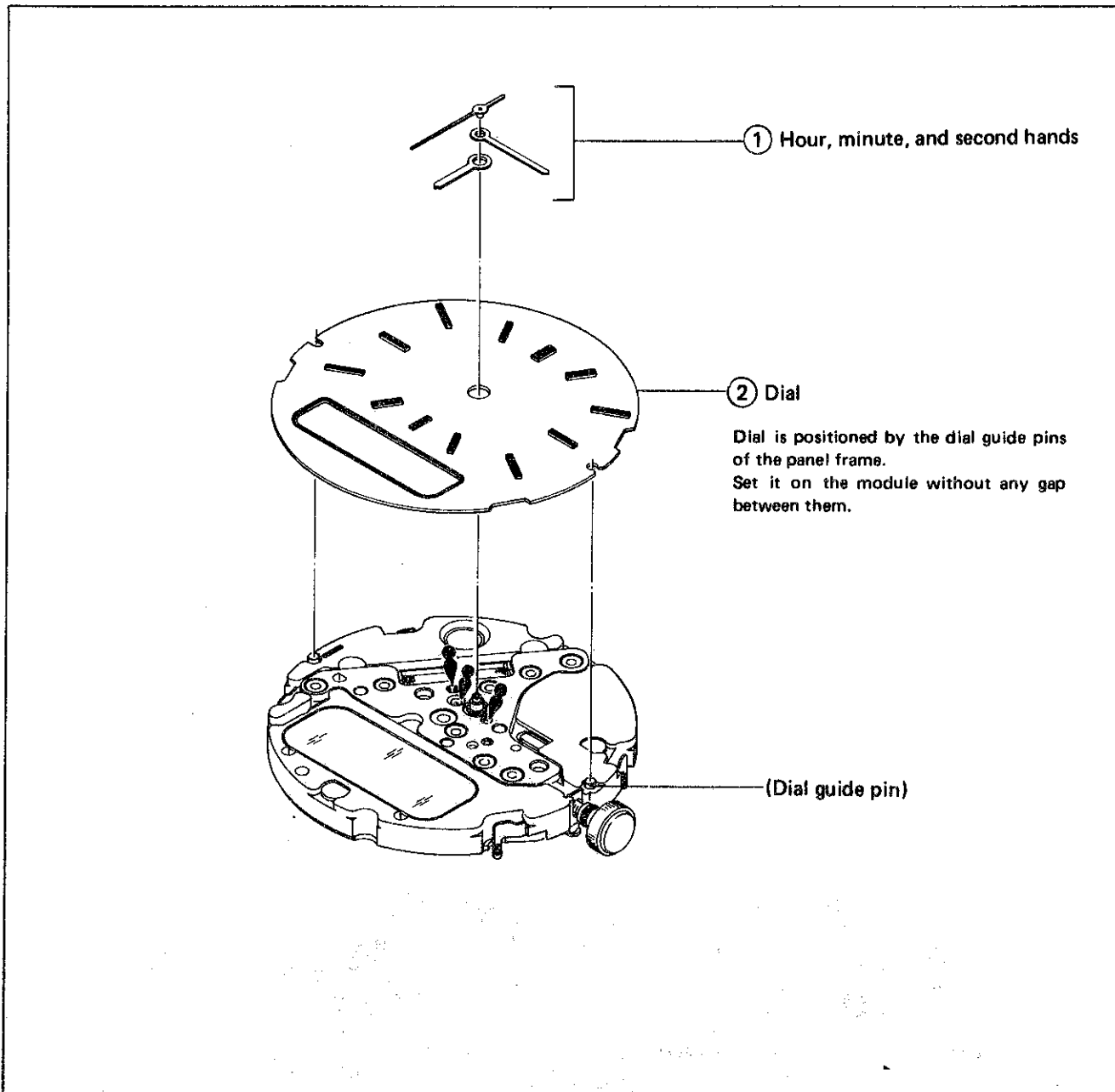

2. Battery clamp screw ~ Winding stem

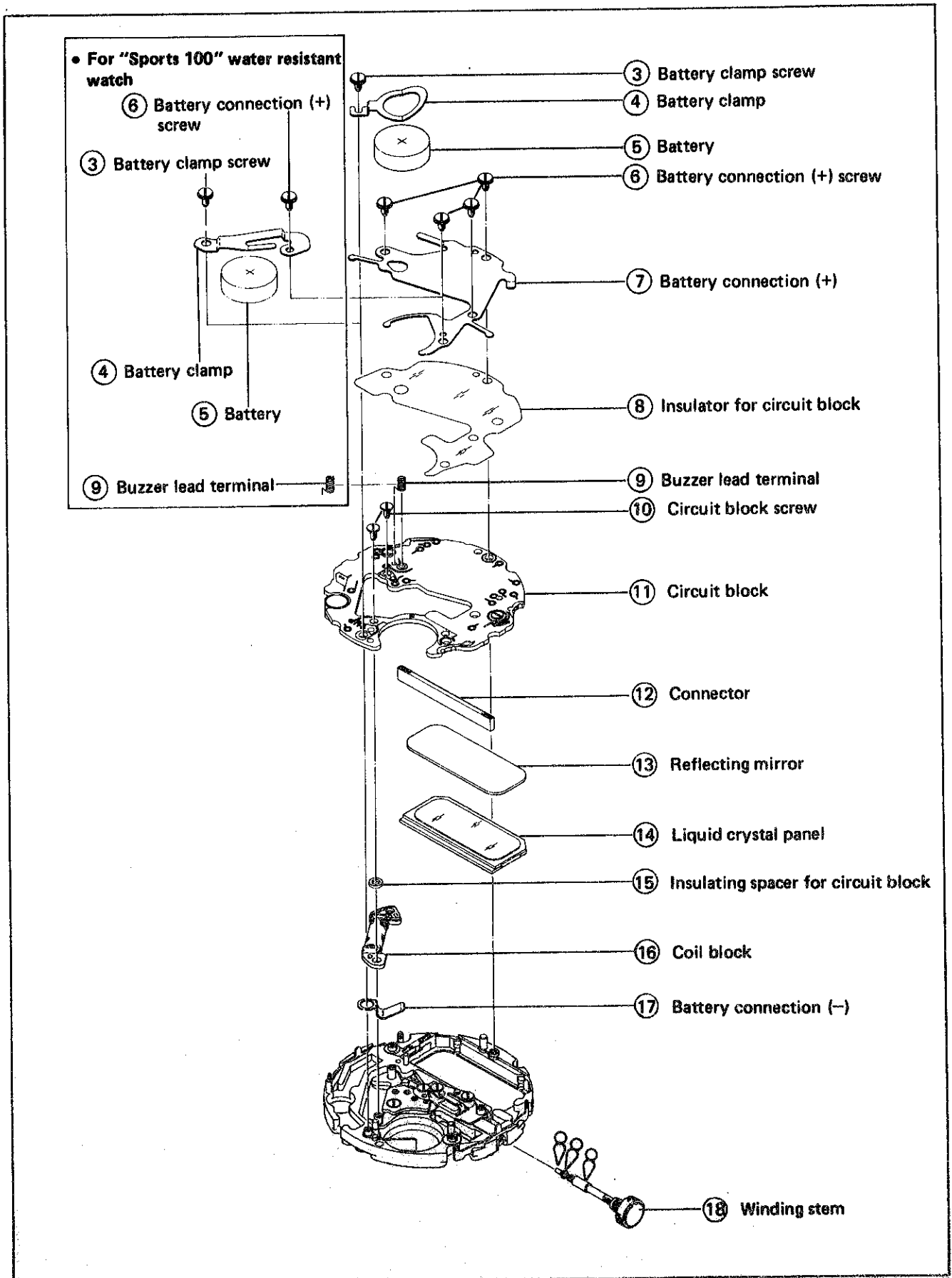

3. Liquid crystal panel frame ~ Main plate

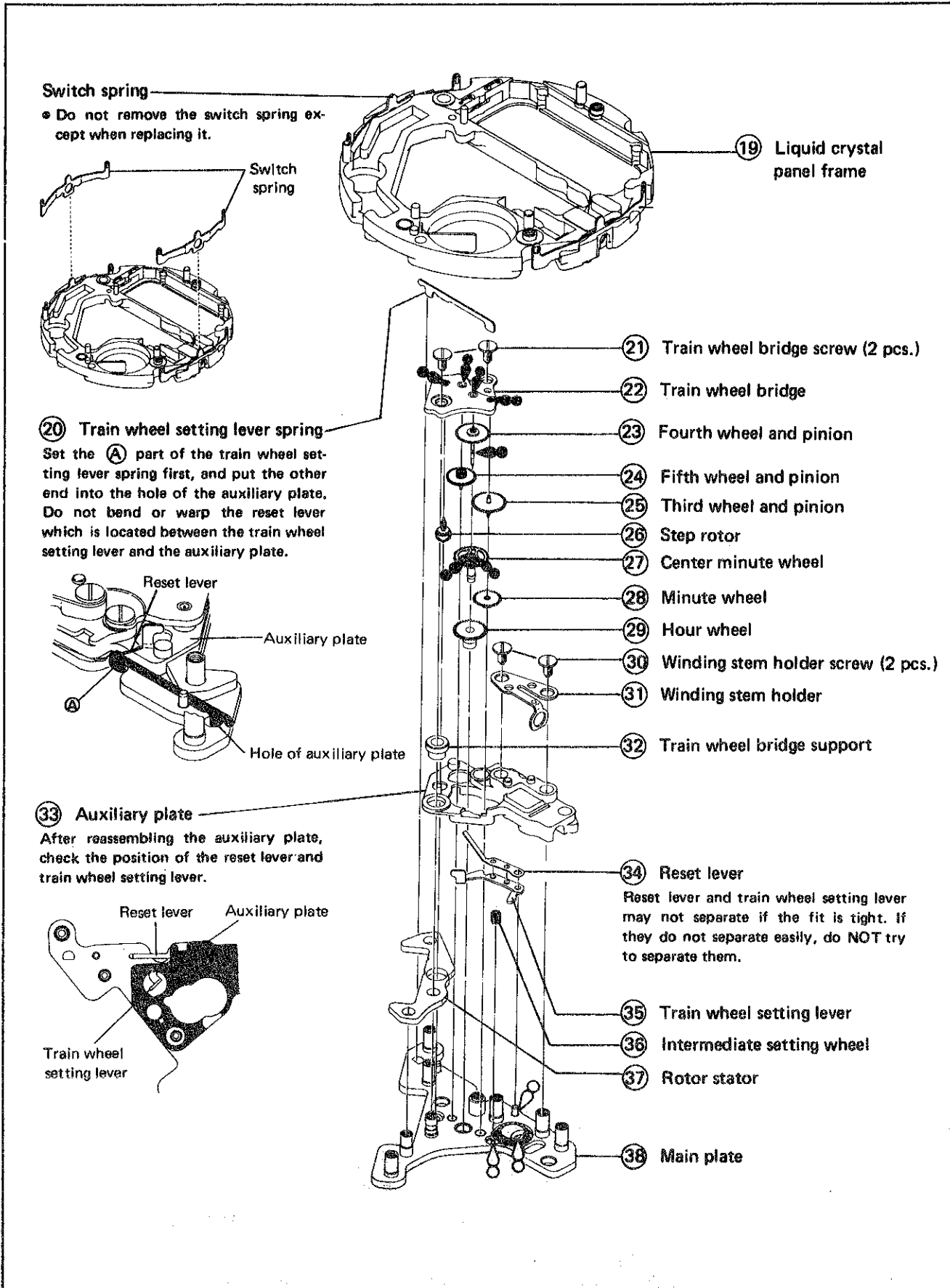

IV. CHECKING AND ADJUSTMENT

- The explanation here is only for the particular points of Cal. H461A.
For details, refer to the "TECHNICAL GUIDE, GENERAL INSTRUCTION" each for SEIKO Analogue Quartz and for SEIKO Digital Quartz.

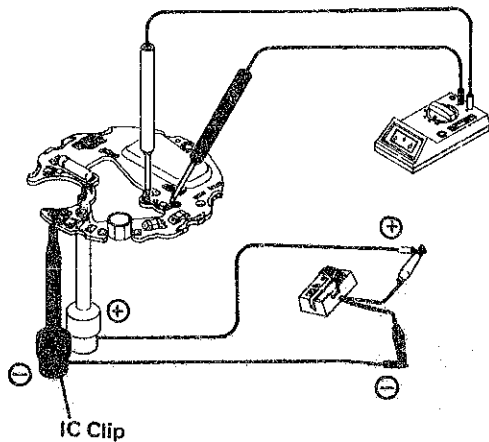
Procedure	
CHECK OUTPUT SIGNAL	<p>Result:</p> <p>Normal: Input indicator blinks every second.</p> <p>Defective: Input indicator does not blink every second.</p>
CHECK BATTERY VOLTAGE	<p>Use the Digital Multi-Tester S-840A. Mode to be used: DC V</p> <p>Result:</p> <p>Normal: More than 1.57V</p> <p>Defective: Less than 1.57V</p>
CHECK COIL BLOCK	<p>Use the Digital Multi-Tester S-840A. Mode to be used: Ω</p> <p>Result:</p> <p>Normal: $2.2K\Omega \sim 2.6K\Omega$</p> <p>Defective — { Less than $2.2K\Omega$ (Short circuit) More than $2.6K\Omega$ (Broken wire)</p>
CHECK LIQUID CRYSTAL PANEL AND CIRCUIT BLOCK	<p>Use the Digital Multi-Tester S-840A. Mode to be used: DC V</p> <p>(1) Check output voltage for the analogue section.</p> <div style="display: flex; align-items: flex-start;"> <div style="flex: 1;">  <p style="margin-left: 20px;">IC Clip</p> </div> <div style="flex: 1; padding-left: 20px;"> <p>Probe red (+) } Output terminal for analogue Probe black (-) }</p> <p>IC Clip red (+) ... Input terminal (+) IC Clip black (-) ... Input terminal (-)</p> <p>Result:</p> <p>Normal: The output voltage is displayed intermittently.</p> <p>Defective: The digits displayed remain unchanged. Replace the circuit block with a new one.</p> </div> </div>

Procedure

(2) Check output voltage for the digital section.

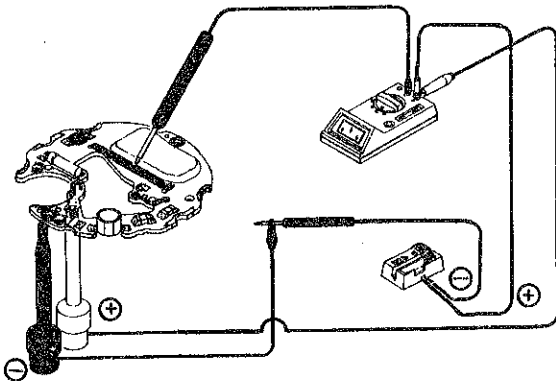

Result:

Normal: More than 1.2V

Defective: Less than 1.2V

Replace the circuit block with a new one.

CHECK CURRENT CONSUMPTION

Use the Digital Multi-Tester S-840A.

Mode to be used: μA

(1) Current consumption for the whole of the movement (module)

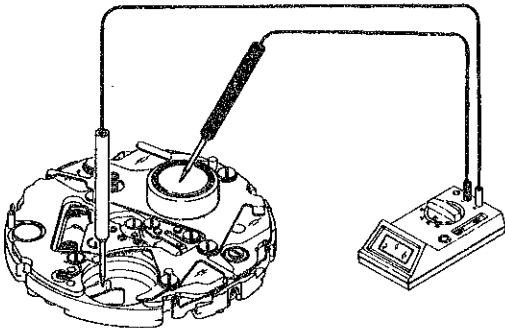

Result:

Normal: Less than $2.8\mu\text{A}$

Defective: More than $2.8\mu\text{A}$

Check current consumption for the circuit block alone.

Probe (+) red Battery connection (-)
Probe (-) black Battery (-) surface

(2) Current consumption for the circuit block alone

Result:

Normal: Less than $1.4\mu\text{A}$

Defective: More than $1.4\mu\text{A}$

Procedure

CHECK ALARM CONDITION

- (1) Check to see if the output voltage for alarm is correctly transmitted from the circuit block.

Activate the alarm test system by keeping buttons B and C at the same time in the time or calendar display.

Use the Digital Multi-Tester S-840A.
Mode to be used: DC V

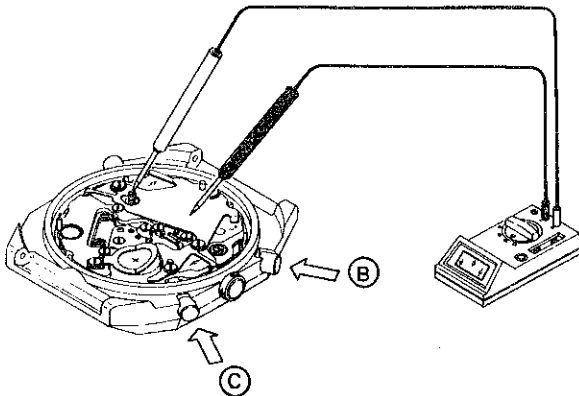

Result:

Normal: The output voltage is displayed intermittently.
Proceed to (3).

Defective: The digits displayed remain unchanged.
Replace the upconverter coil with a new one.

- (2) Check the upconverter coil.

Use the Digital Multi-Tester S-840A.
Mode to be used: Ω

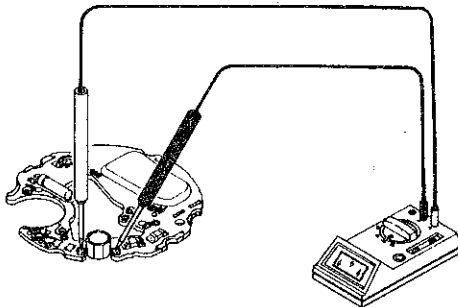

Result:

Normal: $130\Omega \sim 170\Omega$
Proceed to (3).

Defective — $\left\{ \begin{array}{l} \text{Less than } 130\Omega \\ \text{More than } 170\Omega \end{array} \right.$
Replace the circuit block with a new one.

- (3) Check the piezoelectric element.

Check the piezoelectric element to see if there is any crack, chip, peeling, or the like on it.