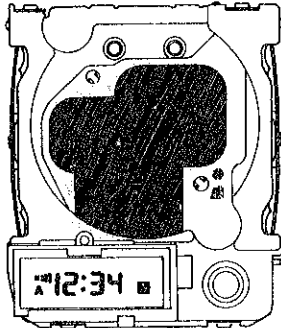
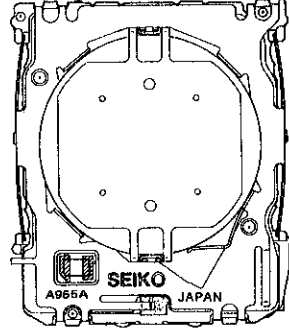

# PARTS CATALOGUE/ TECHNICAL GUIDE

## Cal. A965A Cal. A966A

### [SPECIFICATIONS]

Cal. No.		A965A	A966A
Item			
Module			
		The illustrations refer to Cal. A965A. (x 1.5)	
Module size	Outside diameter	29.5 mm between 6 o'clock and 12 o'clock sides 24.8 mm between 3 o'clock and 9 o'clock sides	
	Casing diameter	—	
	Height	5.2 (6.4 mm including the battery portion)	
Display medium		Nematic Liquid Crystal, FEM (Field Effect Mode)	
Liquid crystal driving system		Multiplex driving system	
Display system		<ul style="list-style-type: none"> <li>• Time display</li> <li>• Alarm display</li> <li>• Voice timer function mark ("T")</li> <li>• Auto speaking function mark ("A")</li> <li>• Language display for bilingual function</li> <li>• "ON"/"OFF" display for voice-off function</li> </ul>	
Additional mechanism		<ul style="list-style-type: none"> <li>• Bilingual function</li> <li>• Voice-off function</li> <li>• Auto speaking function</li> <li>• Voice timer function</li> </ul>	
Loss/gain		Monthly rate at normal temperature range: ±20 seconds	
Regulation system		Nil	
Measuring gate by quartz tester		Any gate can be used.	
Battery		SEIKO CR2016, Maxell CR2016, Sanyo CR2016, MATSUSHITA CR2016, EVEREADY CR2016 Battery life is approximately 2 years. Voltage: 3.0V	

# PARTS CATALOGUE

Cal. A965A, A966A

Disassembling procedures Figs.: ① → ⑱  
 Reassembling procedures Figs.: ⑱ → ①  
**Lubricating:**  
 Types of oil  
 ● Silicone oil 500,000 c.s.      ● Normal quantity

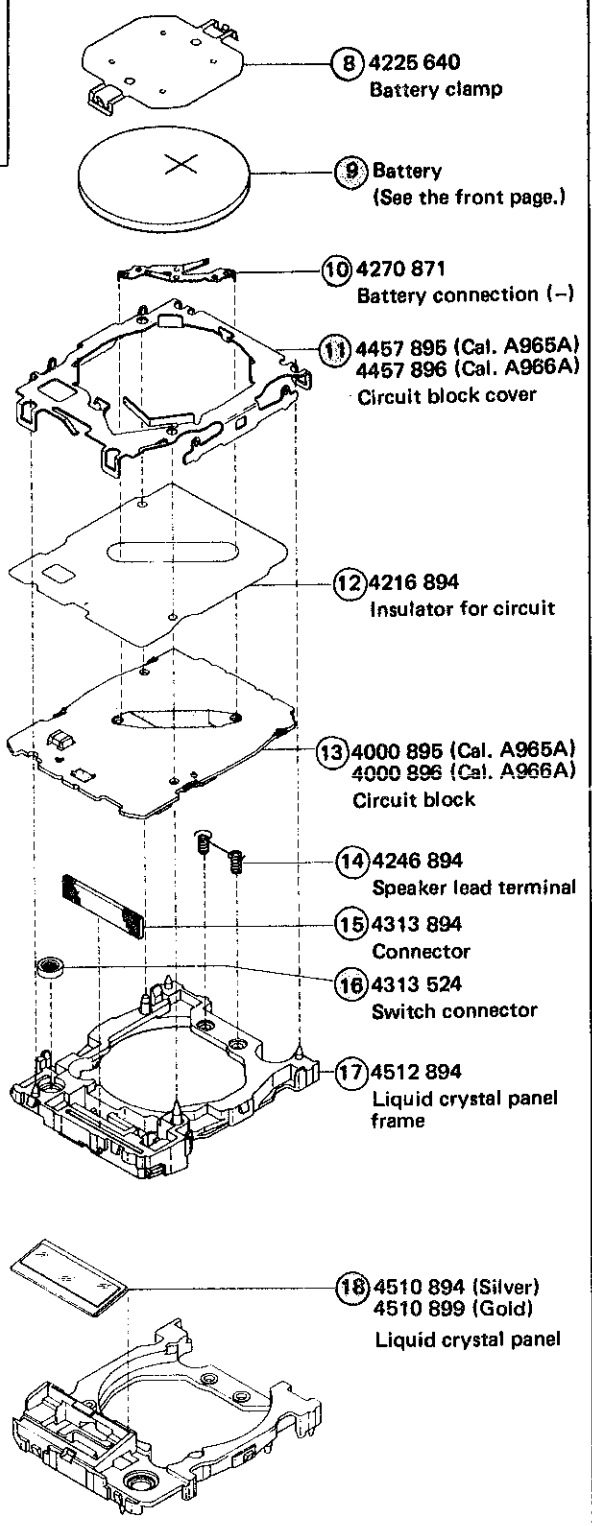
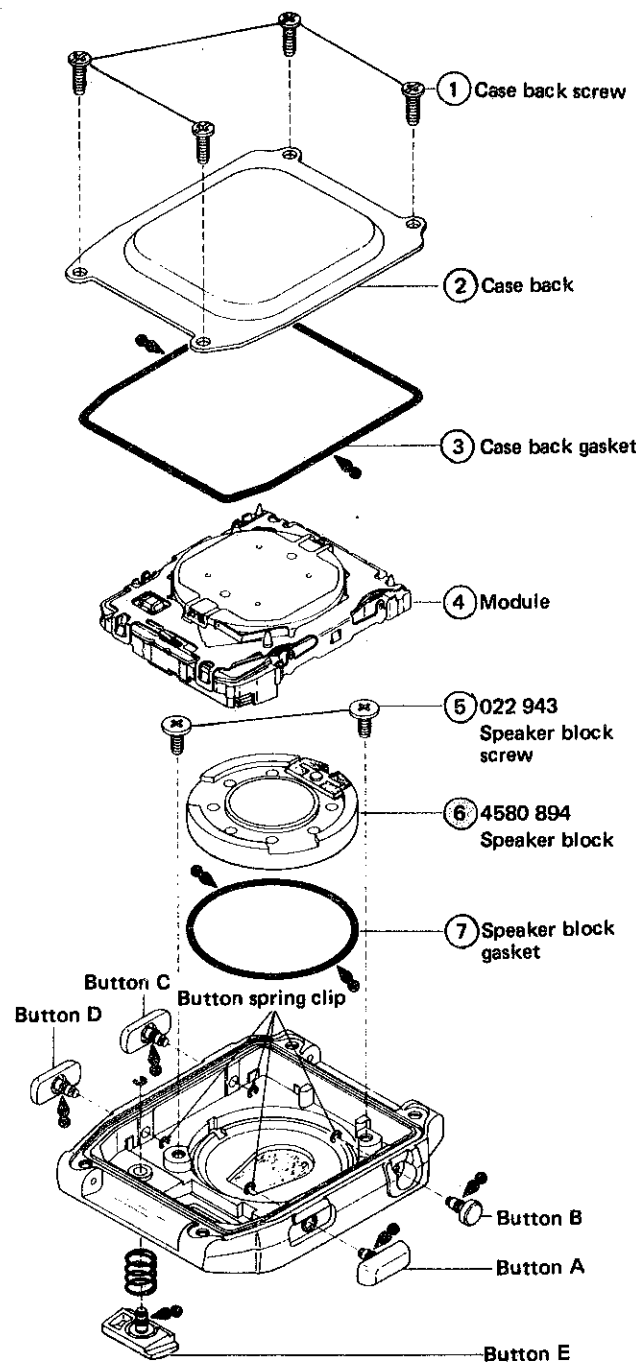

**Remarks:**

⑱ Liquid crystal panel

The type of liquid crystal panel is determined based on the design of cases. Refer to "SEIKO Casing Parts Catalogue" to choose a corresponding liquid crystal panel.

➡ Please see the remarks on the following pages.

- The explanation here is only for the particular points of Cal. A965A and A966A.
- For the repairing, checking and measuring procedures, refer to the "TECHNICAL GUIDE, GENERAL INSTRUCTIONS".

## I. STRUCTURE OF THE CIRCUIT BLOCK

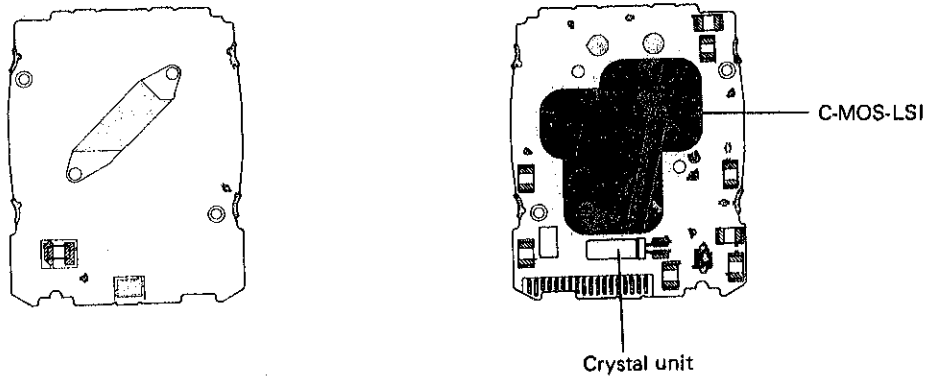

## II. RELATIONSHIP BETWEEN THE SEGMENT (LIQUID CRYSTAL PANEL ELECTRODE) AND THE C-MOS-LSI OUTPUT TERMINAL

- Designation of the segment

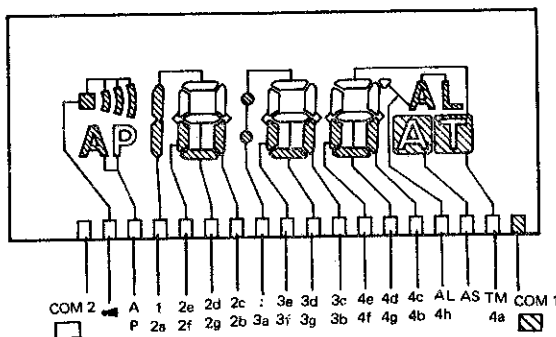
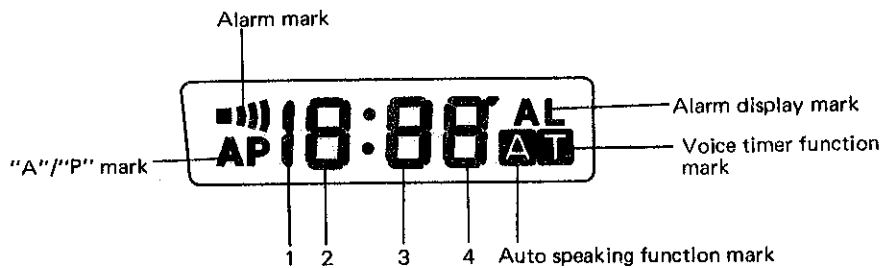
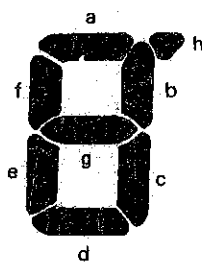

COM 2    A    1    2e    2d    2c    :    3e    3d    3c    4e    4d    4c    AL    AS    TM    COM 1  
 P    2a    2f    2g    2b    3a    3f    3g    3b    4f    4g    4b    4a

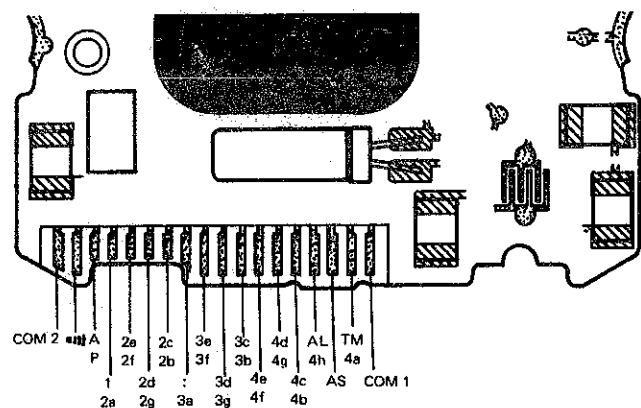

COM 2    A    2f    2c    3f    3c    4d    AL    TM    COM 1  
 1    2d    :    3d    4e    4c    AS    COM 1  
 2a    2g    3a    3g    4f    4b

### III. REMARKS ON INSTALLING THE BATTERY

After the battery is replaced with a new one, or after the battery is re-installed following the repairing procedures, be sure to keep buttons (A), (C), (D) and (E) pressed at the same time for more than 3 seconds to reset the circuit. "A 12:00" will be displayed.

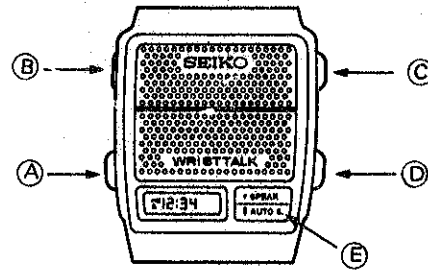

### IV. REMARKS ON DISASSEMBLING AND REASSEMBLING

Use the universal movement holder for disassembling and reassembling.

#### ⑥ Speaker block

##### • How to install

Set the speaker block so that the speaker lead terminal is positioned between the guide protrusions of the case.

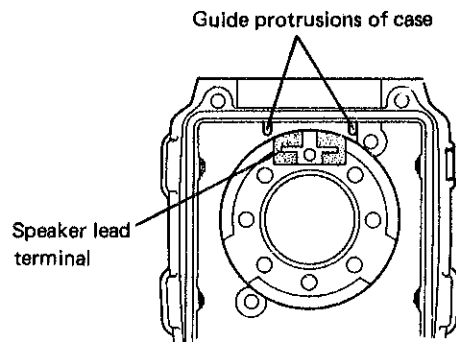

#### ⑨ Battery

##### • How to install

Install the battery with its (-) side down.

#### ⑪ Circuit block cover

##### • How to install

• Set each portion of the circuit block cover to the liquid crystal panel frame in the following order as shown in the illustration.

1. (A) and (B) at the 6 o'clock side
2. (C) and (H) at the 6 o'clock side
3. (D) and (G) at the 12 o'clock side
4. (E) and (F) at the 12 o'clock side

• To set (C), (D), (G) and (H) to the liquid crystal panel frame, put the spring portions into the grooves of the liquid crystal panel as shown in the illustration.

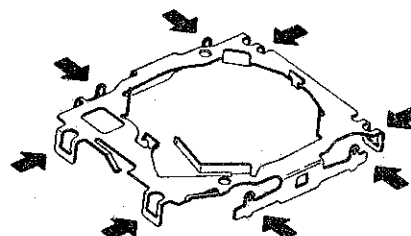
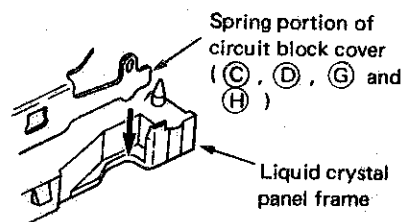
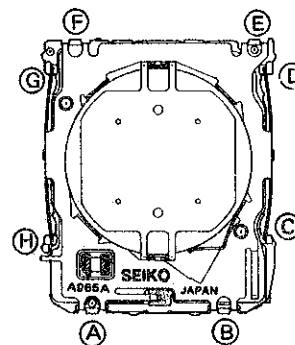

## ⑭ Speaker lead terminal

### ● How to install

Install the speaker lead terminal as shown in the illustration.

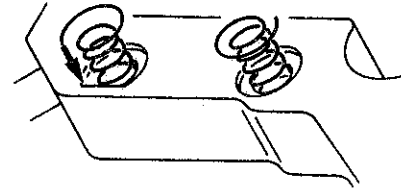

## ⑮ Switch connector

### ● How to install

Set the switch connector in the direction as shown in the illustration.



## ⑰ Liquid crystal panel

### ● How to install

Release the clamping portion of the liquid crystal panel frame by moving it in the direction of the arrow in the illustration with tweezers, and set the liquid crystal panel.

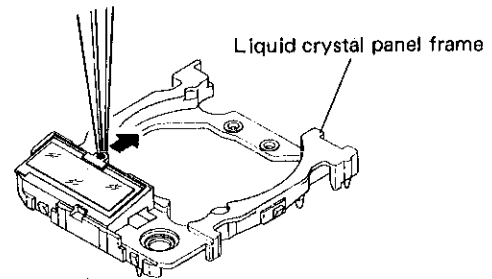

## V. VALUE CHECKING

### ● Speaker block resistance

$54.4\Omega \sim 73.6\Omega$

### ● Current consumption

For the whole of the module: less than  $2.0\mu\text{A}$

For the circuit block alone : less than  $1.6\mu\text{A}$

### ● Time accuracy

- 1) Place the watch on the microphone's mark for placing watch with the liquid crystal panel facing the mark.
- 2) Adjust the level by turning the level adjuster knob.

■ DISPLAY AND BUTTON OPERATION

Button B

- Activation of the TIME SETTING and ALARM SETTING functions.

Button C

- Activation of the VOICE TIMER function.  
By pressing the button in the TIME display, the watch announces the elapsed minutes every minute for 30 minutes.  
\* Button C will not work while in the ALARM display.

Button A

- Changeover of displays between TIME and ALARM displays.  
\* If the watch is left untouched in the ALARM display, the display will automatically return to the TIME in 1 to 2 minutes.

Button D

- Selection of the language in which the watch announces the time.  
With each continuous press of the button in the TIME display, the language changes over between English and German for Cal. A965A and English and Spanish for Cal. A966A.
- Engagement/disengagement of the alarm.  
With each press of the button in the ALARM display, the alarm is engaged and disengaged alternately.

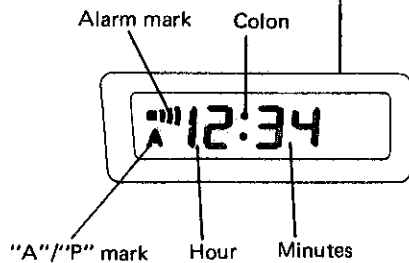

Button E ("SPEAKING" button)

- In the TIME display, the watch announces the current time with each press of the button. With two successive presses of the button, the AUTO SPEAKING function is activated, and the watch successively announces the current time with every lapse of a minute for 14 minutes.
- By pressing the button in the ALARM display, the watch announces the designated alarm time when the alarm is engaged and announces "Alarm off" when it is disengaged.

■ WATCH OPERATION (while the speaking function is activated)

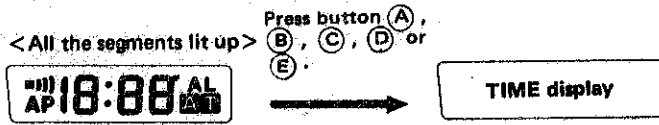

Press buttons (A), (C) and (D) at the same time.

(In the TIME SETTING display, the watch stops operating and will start from "00" seconds when it returns to the TIME display.)

TIME SETTING display

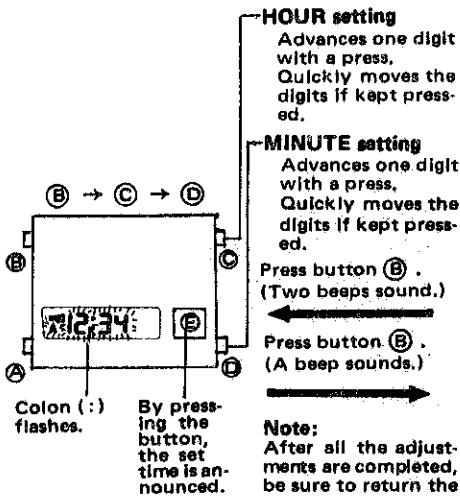

**Note:** After all the adjustments are completed, be sure to return the display to TIME. Otherwise, the watch will not start operating.

The display will automatically return to the TIME in 1 to 2 minutes.

ALARM SETTING display

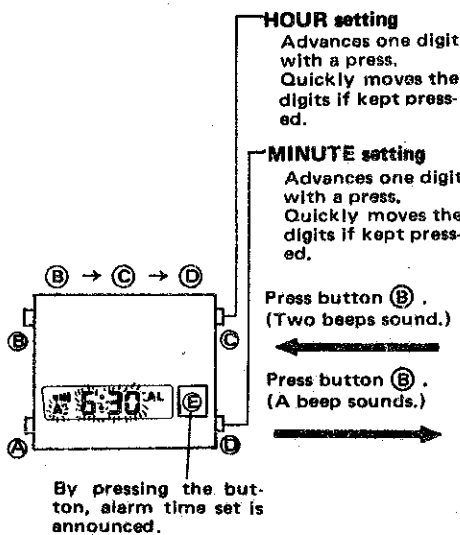

ALARM display

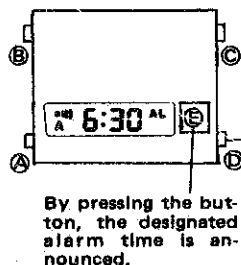

Button (C) : VOICE TIMER FUNCTION

- The voice timer starts with a press of the button.
- The elapsed minutes are announced every minute for 30 minutes.
- To stop the timer, press button (A), (B), (C), (D), or (E).
- While the voice timer function is activated, flashing "T" is shown on the display.



Flashes to indicate that the voice timer function is activated.

Button (D) : "BILINGUAL" FUNCTION (English/German for Cal. A965A and English / Spanish for Cal. A966A)

- With each continuous press of the button, the language in which the watch announces the time changes over.
- The language can be selected from English and German for Cal. A965A and English and Spanish for Cal. A966A.

[Cal. A965A]

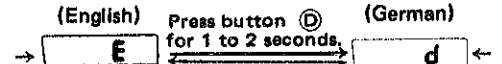

[Cal. A966A]

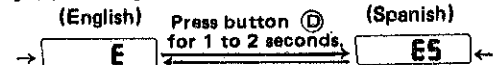

- \* The indications for the respective languages are displayed only while button (D) is kept pressed.
- \* The watch will announce the time in the language selected.

Button (E) : SPEAKING FUNCTION

- With a press of the button, the watch announces the current time.

Button (E) : AUTO SPEAKING FUNCTION

- The auto speaking function is activated by pressing the button twice successively.
- The watch successively announces the current time with every lapse of a minute for 14 minutes.
- To stop the auto speaking function manually, press button (A), (B), (C), (D) or (E).
- While the auto speaking function is activated, flashing "A" is shown on the display.



Flashes to indicate that the auto speaking function is activated.

Button (D) : Engagement/disengagement of the alarm

- With each press of the button, the alarm is engaged and disengaged alternately.

[Alarm engaged]

[Alarm disengaged]

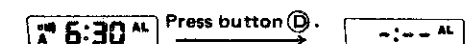

By pressing button (E), the designated alarm time is announced.

By pressing button (E), "Alarm off" is announced.

Button (D) : Alarm test

- The alarm can be tested by continuously pressing the button in the ALARM display.
- Note that, by doing so, the alarm is engaged and disengaged alternately with each press of the button.

### "VOICE OFF" FUNCTION

- With each continuous press of both buttons (A) and (D), the speaking function is activated and deactivated alternately.

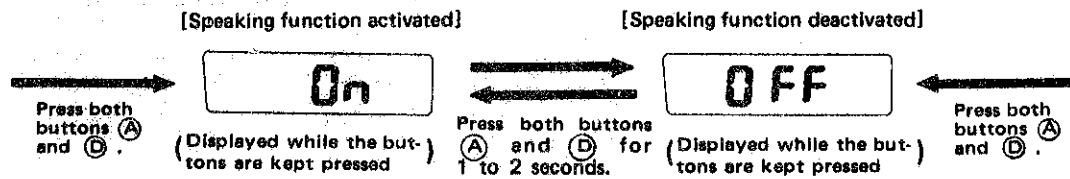

### BUTTON OPERATION WHILE THE SPEAKING FUNCTION IS DEACTIVATED

- While the speaking function is deactivated, the watch will not announce the time and beep does not sound.

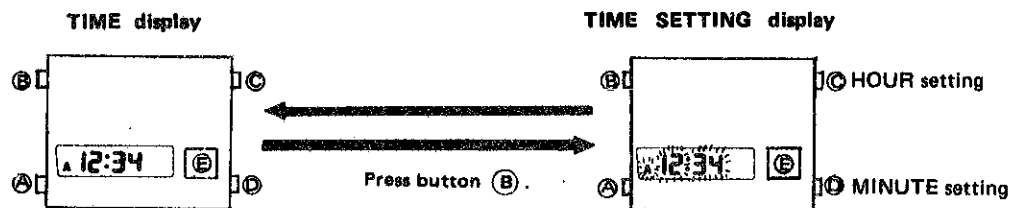

- By pressing any of the buttons (A), (C), (D) and (E), "OFF" is displayed while the button is kept pressed.
- The display will not change over even if button (A) is pressed.
- By pressing button (E), "OFF" is displayed while the button is kept pressed.